

Betty 150x70

PREDINSTALACIJA
PREINSTALLATION
VORINSTALLATION

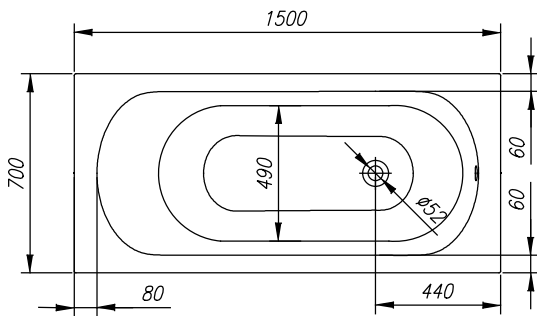
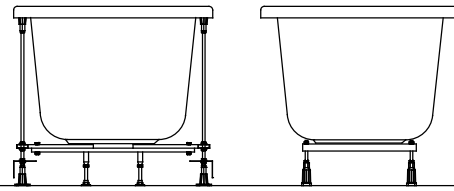
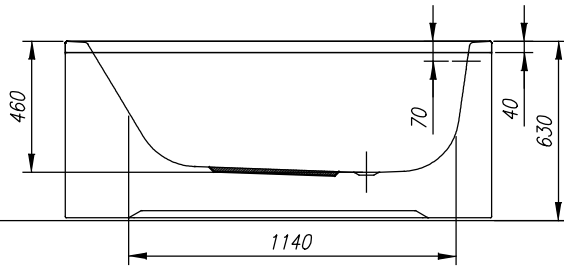
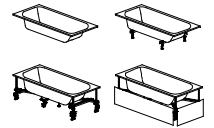

180 L

VOLUMEN
VOLUMEN
VOLUME
VOLUMEN

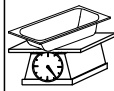

21 kg

TEŽA
TEŽINA
WEIGHT
GEWICHT

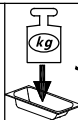

305 kg

MAX. OBREMENITEV
MAX. OBTEREČENJE
MAX. LOAD
MAX. BELASTUNG

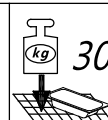

305 kg/m²

OBREMENITEV TAL
OBTEREČENJE PODA
FLOOR LOAD
BODENBELASTUNG



- Priklop tople in hladne vode 1/2", min 0,2 Mpa, max 0,4 Mpa
- Priključak tople i hladne vode 1/2", min 0,2 Mpa, max 0,4 Mpa
- Connection of hot and cold water 1/2", min 0.2Mpa, max 0.4Mpa
- Anschluss Warm- und Kaltwasser 1/2", min 0,2 Mpa, max 0,4 Mpa



- Prostor za odtok Ø 50 mm
- Mjesto za odtok Ø 50 mm
- Drain spot Ø 50mm
- Abflussplatz Ø 50 mm



- Opcija-obloga
- Opcija-obloga
- Panel - option
- Möglichkeit - Schürze

priporočilo za vgradnjo
preporuka za ugradnjo
installation recommendation
Einbauempfehlung

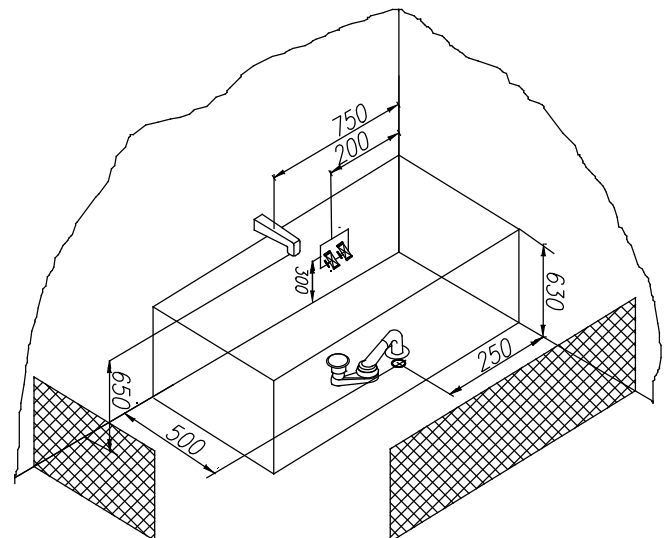

Priporočena prelivna garnitura
Preporuka prelivne garniture
Recommended overflow set
Vorgeschlagene Überlaufgarnitur

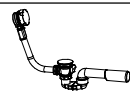

PAL 650

kopalna kad brez oblog - navodilo za vgradnjo
Kada bez obloge - upute za ugradnjo
Bathtub without panel - installation instructions
Badewanne ohne Schürze - Einbauanleitung

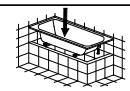

Nr. MK 03

Opcija podnožja za kadi brez obloge
Varianta postolja za kade bez obloge
Option of the built-in bathtub base
Möglichkeit des Sockels für die Badewannen ohne Schürze

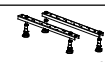

Nr. MK 05
PKK 501

Kopalna kad z oblogo - navodilo za vgradnjo
Kada s oblogom - upute za ugradnjo
Bathtub with panel - installation instructions
Badewanne mit Schürze - Einbauanleitung

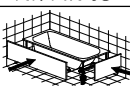

Nr. MK 01

Opcija podnožja za kadi z oblogo
Varianta postolja za kade sa oblogom
Option of the bathtub base with panel
Möglichkeit des Sockels für die Badewannen mit Schürze

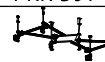

Nr. MK 11
CM 130-150

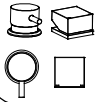

- MEŠALNI VENTIL TOPLA/HLADNA
- VENTIL ZA MIEŠANJE TOPLO/HLADNO
- MIXING VALVE HOT/COLD
- MISCHVENTIL WARM/KALT



- PREKLOPNIK ROČNA PRHA/IZLIV
- PREKIDAČ ZA RUČNI TUŠ/IZLJEV
- HAND SHOWER/SPOUT SELECTOR SWITCH
- SCHALTER FÜR HANDBRAUSE/AUSLAUF

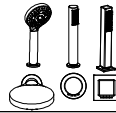

- ROČNA PRHA
- RUČNI TUŠ
- HAND SHOWER
- HANDBRAUSE

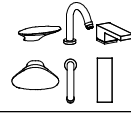

- IZLIV
- IZLJEVNIK
- SPOUT
- AUSLAUF

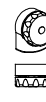

- IZLIV NA PRELIVNI GARNITURI
- IZLJEV NA PRELJEVNOM SETU
- SPOUT ON THE OVERFLOW SET
- AUSLAUF AN DER ÜBERLAUFGARNITUR

- OPCIJA ENOROČNA ARMATURA GEYSER
- OPCIJA JEDNORUČNA ARMATURA GEYSER
- OPTION ONE HAND FITTING GEYSER
- MÖGLICHKEIT EINWEG-ARMATUR GEYSER

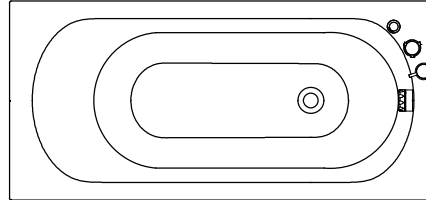
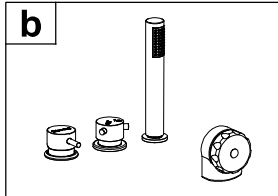

- OPCIJA ENOROČNA ARMATURA RAINDROP
- OPCIJA JEDNORUČNA ARMATURA RAINDROP
- OPTION ONE HAND FITTING RAINDROP
- MÖGLICHKEIT EINWEG-ARMATUR RAINDROP

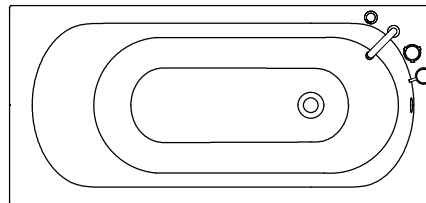
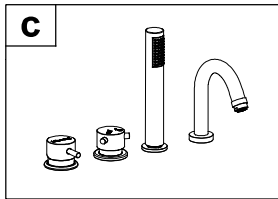

- OPCIJA ENOROČNA ARMATURA STREAM (CHR / BLACK)
- OPCIJA JEDNORUČNA ARMATURA STREAM (CHR / BLACK)
- OPTION ONE HAND FITTING STREAM (CHR / BLACK)
- MÖGLICHKEIT EINWEG-ARMATUR STREAM (CHR / BLACK)

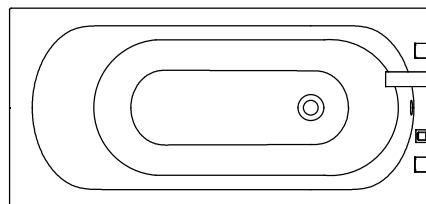
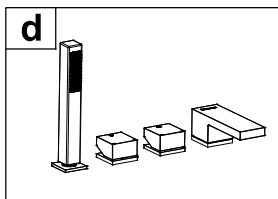

V NAVEDENO KOPALNO KAD NE VGRAJUJEMO MASAŽNIH SISTEMOV

U NAVEDENU KUPAONSKU KADU NE UGRAĐUJEMO MASAŽNIH SISTEMOV

WE DO NOT INSTALL MASSAGE SYSTEMS IN THE GIVEN BATHTUB

IN DER ANGEGEBENEN BADEWANNE WERDEN MASSAGESYSTEMEN NICHT EINGEBAUT

OPCIJE OPCIJE OPTIONS MÖGLICHKEITEN

- POLOŽAJ OBLOG NA KOPALNI KADI
- POZICIJA OBLOGE NA KADI
- PANEL POSITIONS ON THE BATH
- POSITION DER SHÜRZE FÜR BADEWANNE

